

**BIOLOID**

ROBOTIS EXCLUSIVE  
DISTRIBUTOR:  
RO-BOTICA GLOBAL S.L.  
C/ Hercegovina 22, bajos  
08006 Barcelona (Spain)  
www.ro-botica.com  
Tel: +34 934 143 581  
info@ro-botica.com



# Bioloid

## Premium Kit

### Robot Flower

# Assembly Manual



# Attention!

Before proceeding with assembly, you must ensure each actuator's horn is properly aligned. To visually verify proper alignment, the notch from the horn should be in line with the notch from the actuator's body.

If not, perform one of the following actions:

A. Turn the horn manually until its properly aligned.

B. Use Dynamixel Wizard.

1. Start RoboPlus and run Dynamixel Wizard.
2. Connect the actuator to the computer through USB2Dynamixel. Don't forget to supply power to the actuator separately.
3. Select the correct port, click on the **Open Port** icon, and click on **Start Search**.
4. On address 30, Goal Position, click on **Center Position**. Dynamixel Wizard will then align the horn; you can visually verify horn alignment afterwards.

(For more information, please refer to Dynamixel Management.)

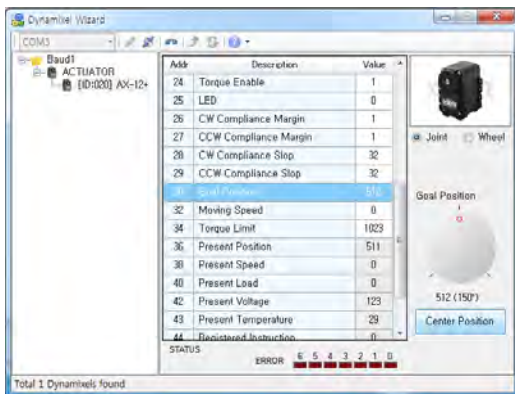

Dynamixel Wizard



properly aligned horn

\*Some robots may require a specific horn alignment before assembly. Please follow assembly instructions closely if such horn alignment is necessary.

## Tips!

- I. Always assign ID numbers to the actuators before assembly. Robotis recommends you assign ID's by one actuator at a time.
- II. You may need apply gentle pressure to fit nuts into the actuator's body. The tight fit is necessary to facilitate assembly.
  - A. Insert only one nut at a time.
  - B. Use your screwdriver to apply pressure on the nut.
  - C. Point the screwdriver away from your body and away from other people.

# Bioloid Robot Flower – Getting Started

## STEP 1

Attach F2 to F9. (Make 3 sets.)

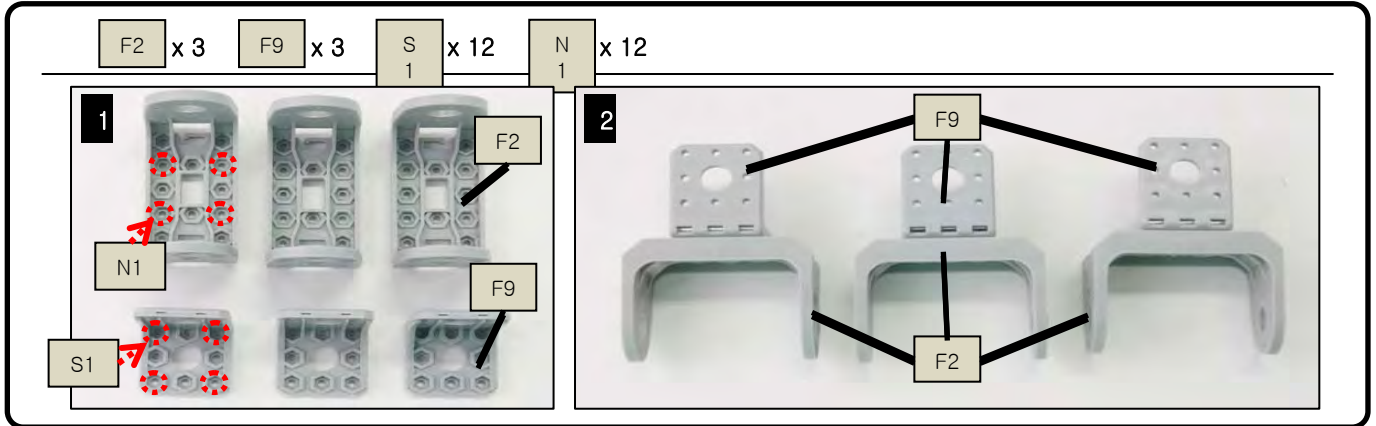

## STEP 2

Attach F1 to F3. (Make 3 sets.)

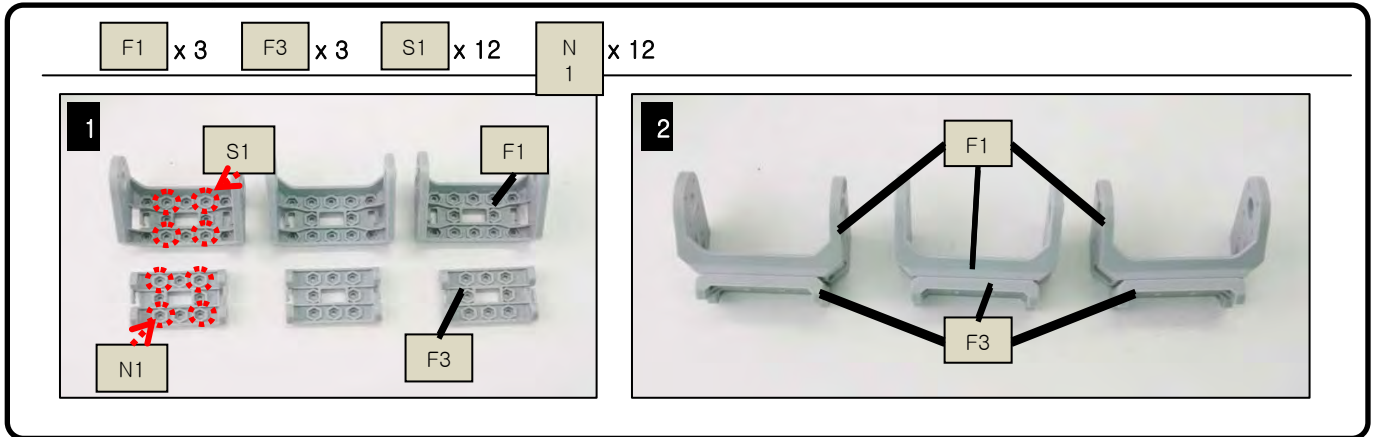

## STEP 3

Attach STEP 1, STEP 2, ID1, ID2, ID4, and ID5 together. (Do not misalign horn position.)

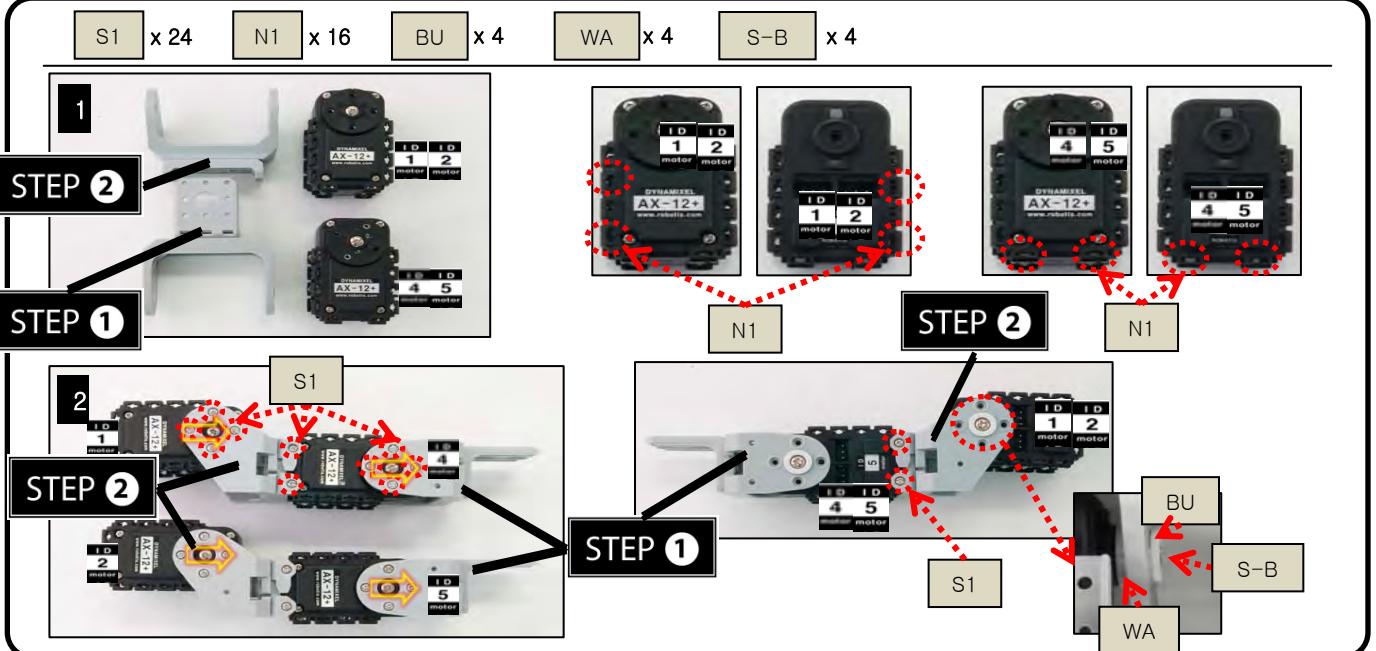

## STEP 4

Attach STEP①, STEP②, ID3, and ID6 together. (Do not misalign horn position.)

S1 x 12   N1 x 8   BU x 2   WA x 2   S-B x 2

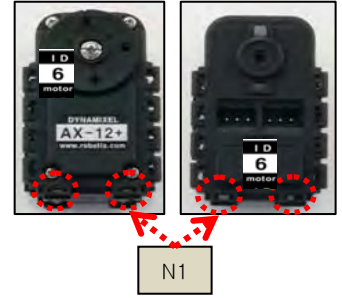
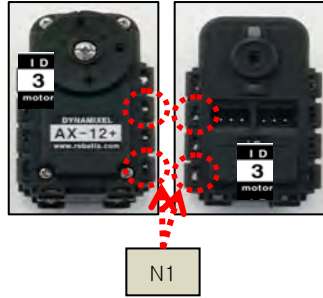
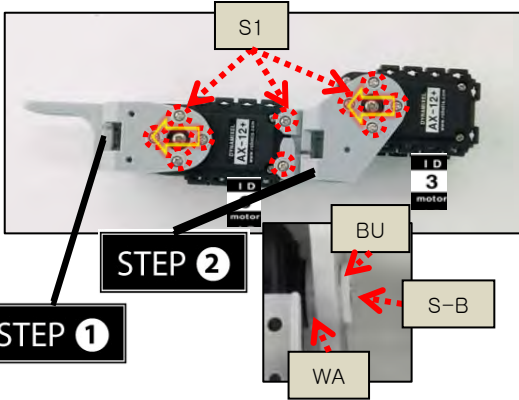

## STEP 5

Attach F3, F10, F52, and F60 together.

F3 x 4   F10 x 1   F52 x 1   F60 x 1   S1 x 6   S2 x 2   S13 x 2   N1 x 8

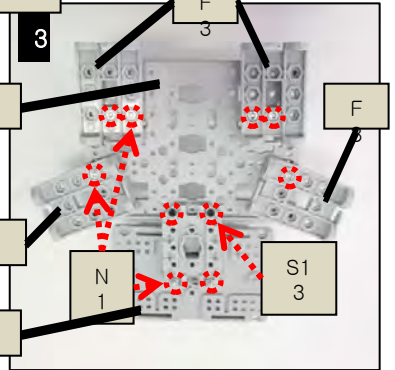
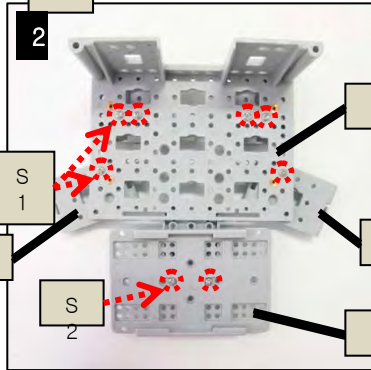
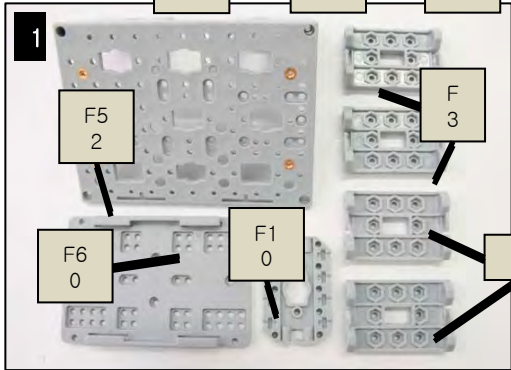

## STEP 6

Attach F3 to F51.

F3 x 3   F51 x 1   S1 x 6   N1 x 6

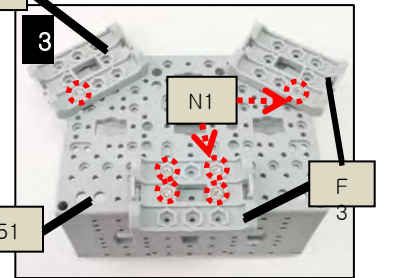
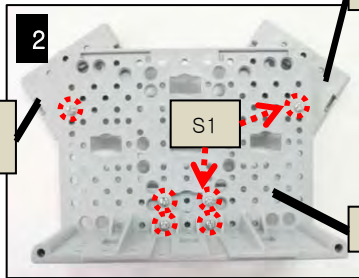
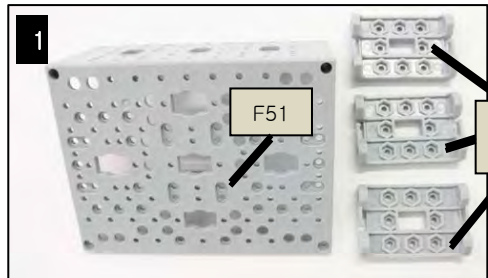

## STEP 7

Attach STEP⑤ to STEP⑥.

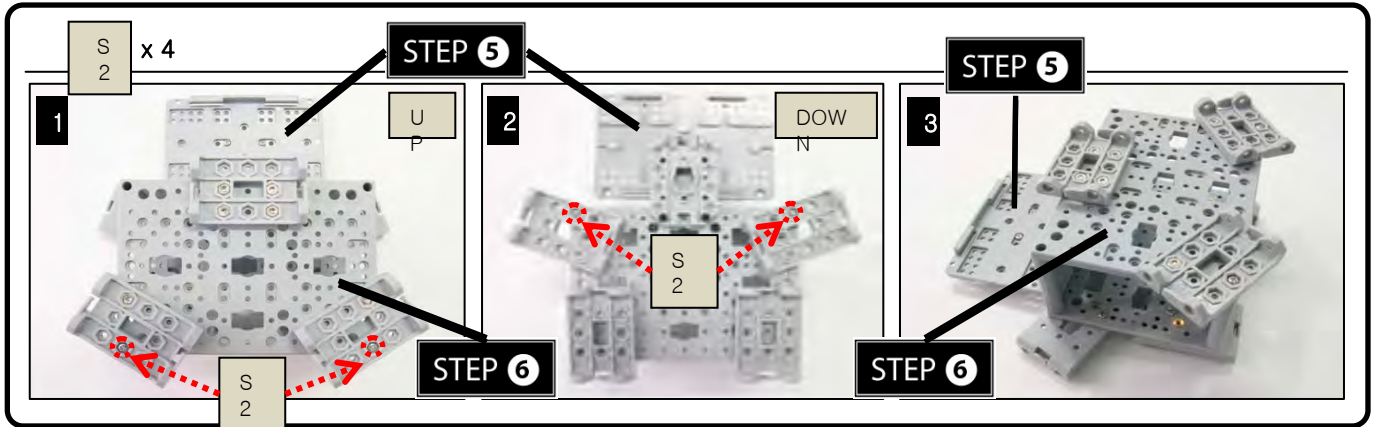

## STEP 8

Attach STEP③, STEP④, and STEP⑦ together.

With 3 CABLE-10, connect ID1 to ID4; ID2 to ID5; ID3 to ID6.

Connect ID1, ID2, and ID3 to CM-510 each with CABLE-20.

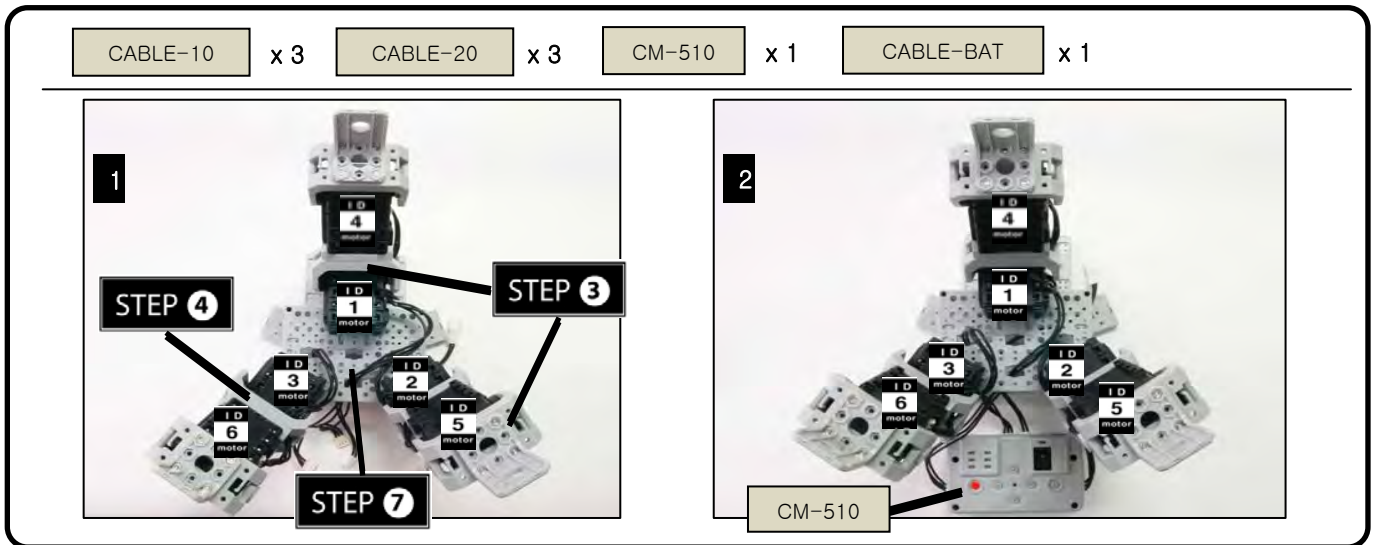

## STEP 9

Connect the battery through the battery cable.

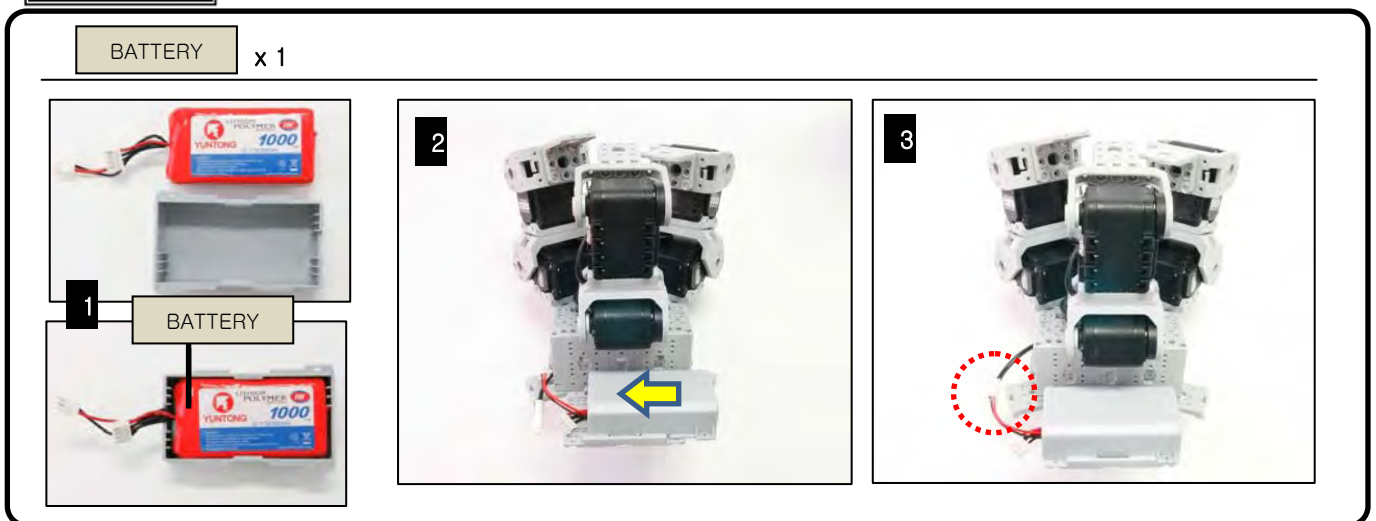



# Assembly Check

After assembly please check the following procedure to ensure correctness.

## STEP 1

### Run the assembly check program

Set the robot in **PLAY** mode; hold the **D** button then press **START**.

Once the **START** button is pressed, the assembly check program begins.

## STEP 2

### AX12+ initial position and ID check

Select each actuator separately and compare it to the picture below.

Ensure the actuators' horns are properly aligned (the horn's notch should be aligned with the actuator's).

Pressing the **U** or **D** button selects one actuator at a time.

The selected actuator's LED lights up and goes to its initial position.

Check starts from ID1.

**U** moves to the next ID in ascending numerical order; **D**, in descending numerical order.

If the actuator's ID does not exist then the robot beeps.

Although the LED may lit, if there is no power then check the wiring on the actuator.

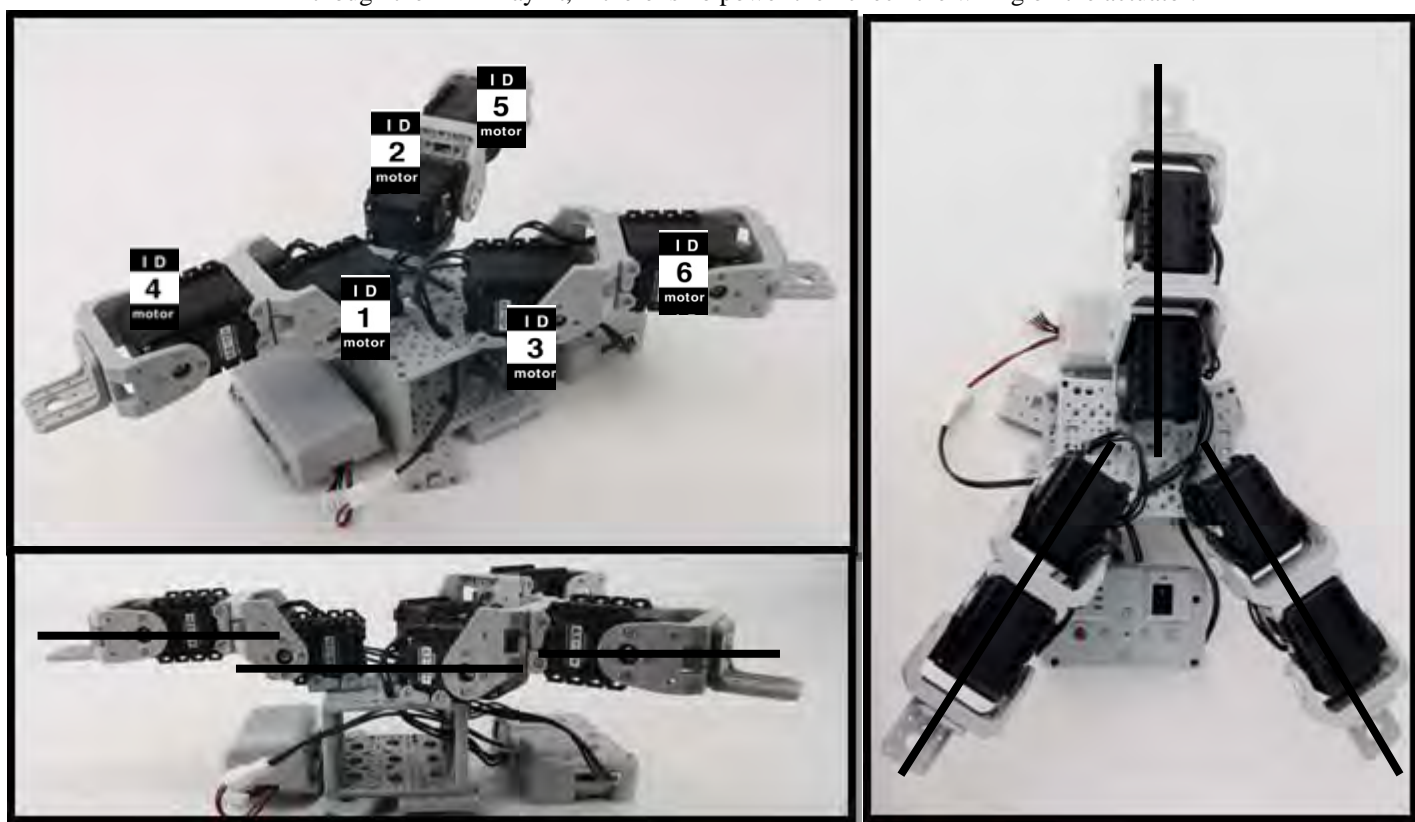

## STEP 3

### Sensor and behavior check

From STEP② press **R**. The robot returns to its initial position as pictured above.

Place your hand close to the sensors as pictured below. Robot behavior begins.

If the robot does not behave as pictured below, then check the sensor wiring and its port.

Pressing **L** will return the robot back to STEP②.

## STEP 4

### If everything works fine, play the robot.

Set the robot in **PLAY** mode and press **START**. The robot will play.